

Overview

Set Up Your Smart Garage Control

Need Help?

Accessories and Parts

CHAMBERLAIN®

Smart Garage® Control



All versions of
MYQ-G0401

 See How-To Video

Overview

What's in the Box

Specifications

Get to Know your Smart Garage Control

Buttons and LEDs

Set Up Your Smart Garage Control

Need Help?

Accessories and Parts

Overview

What's in the Box



Hub



Door Sensor



Hook and Loop Adhesive Strips for Door Sensor

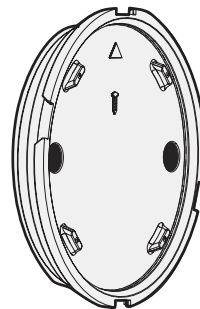

Mounting Plate

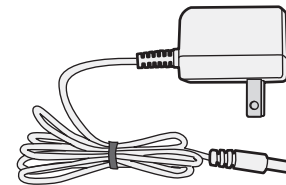

Power Adapter



Screws for Door Sensor

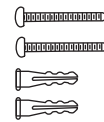

Anchors and Screws for Hub



Warning Placard

Specifications

- Smart Garage® Control can control up to 2 garage door openers (requires a second door sensor, sold separately, see [Accessories and Parts](#).)
- Smart Garage Control can control up to 16 myQ® accessories.
- Operating temperature: -4° to 149° F (-20° to 65° C).
- For use with sectional garage doors ONLY.
- The garage door MUST have safety sensors installed.
- 2.4 GHz Wi-Fi with WPA, WPA2, WPA2/3 and WPA3 security protocols.
- IPv4 and IPv6 compatible.
- Smart Garage Control is compatible with myQ commercial door operators.
- Smart Garage Control is NOT compatible with gate operators.

Overview

What's in the Box

Specifications

Get to Know your Smart Garage Control

Buttons and LEDs

Set Up Your Smart Garage Control

Need Help?

Accessories and Parts

Overview

Get to Know your Smart Garage Control

Smart Garage Control lets you control up to 2 garage door openers, and 16 devices from the myQ App.

See [Accessories and Parts](#).

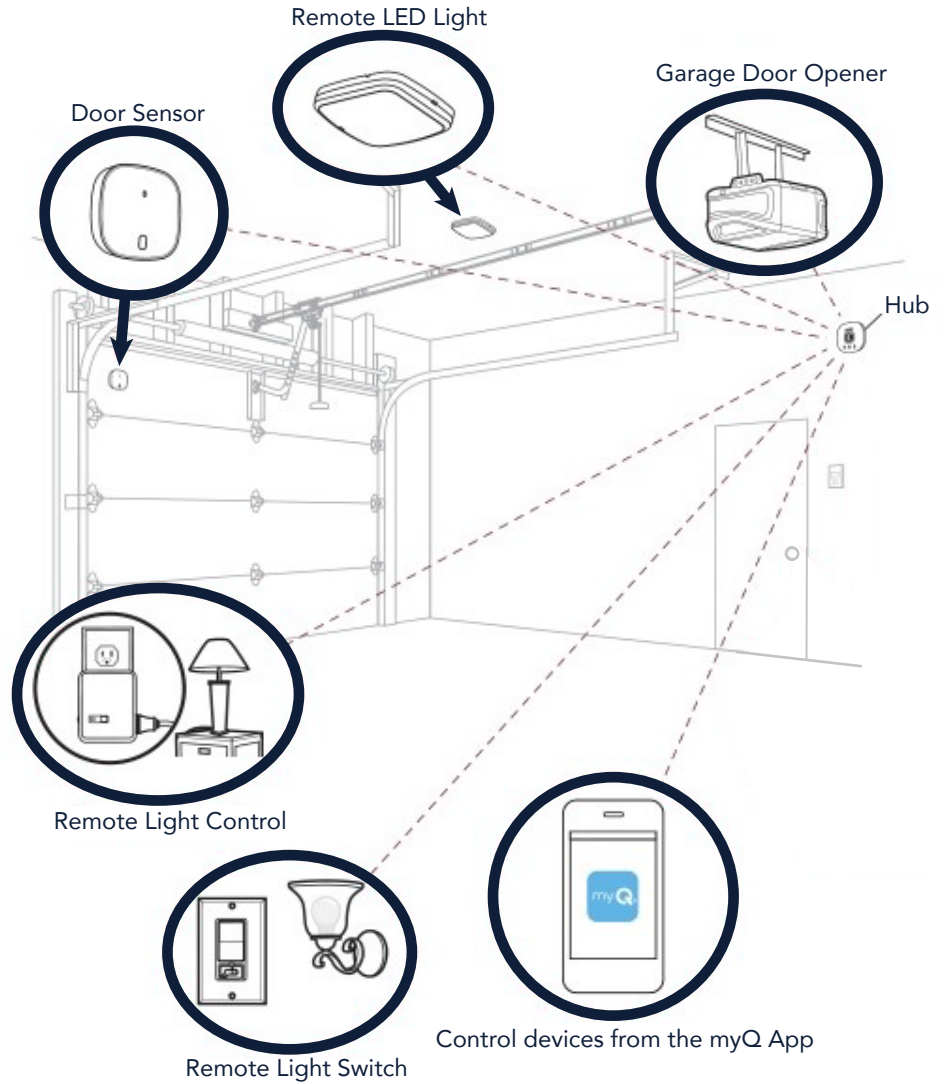

Overview

What's in the Box

Specifications

Get to Know your Smart Garage Control

Buttons and LEDs

Set Up Your Smart Garage Control

Need Help?

Accessories and Parts

Overview

Buttons and LEDs

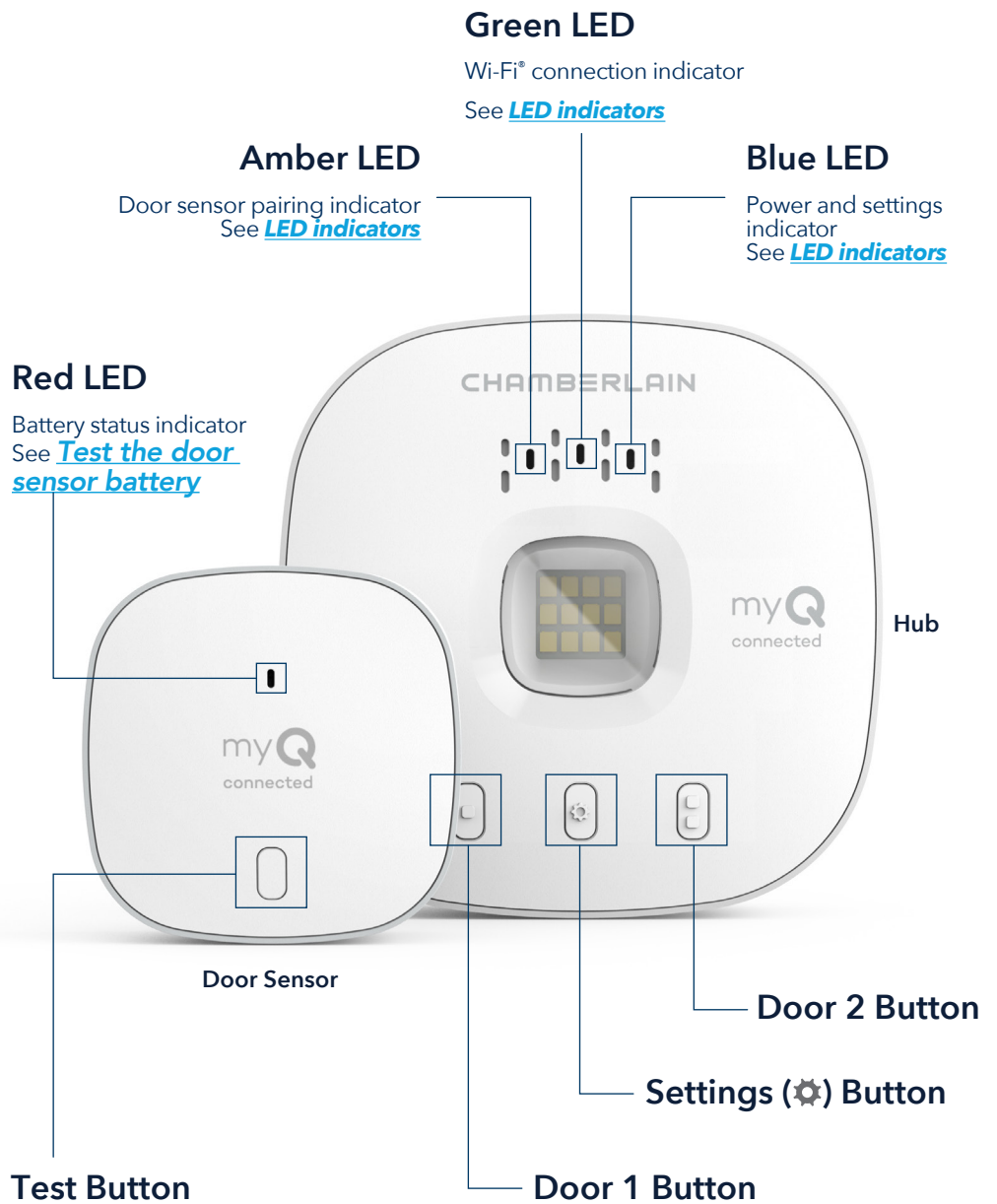

Overview

Set Up Your Smart Garage Control

What you Need

Connect Your Smart Garage Control

Check Your Wi-Fi Signal

Pair the Door Sensor to the Hub

Pair a second door sensor

Mount the Door Sensor

Choose the Hub Location

Mount the Hub

How-To Video

Add myQ Smart Partners and Accessories

Need Help?

Accessories and Parts

Set Up Your Smart Garage Control

What You Need

- Access to your compatible garage door opener, [check opener compatibility by manufacturer](#)
- A strong Wi-Fi signal in the garage, [see Check Your Wi-Fi Signal](#)
- Your Wi-Fi network password
- A ladder
- A drill with 5/32" bit
- A Phillips screwdriver
- Bluetooth enabled on your mobile device

Connect Your Smart Garage Control



1. Download the myQ app.

If you have already installed the app, make sure you have the latest version to optimize your myQ experience.

2. Set up your account and log in.

3. Tap (+) to add your Smart Garage Control.

The app will guide you through installing and connecting your Smart Garage Control and show you how to:

Connect the hub to your home Wi-Fi network.

- a. Connect the hub to your home Wi-Fi network.
- b. [Pair the Door Sensor to the Hub.](#)
- c. [Mount the door sensor.](#)
- d. Pair the hub to your garage door opener.
- e. [Mount the Hub.](#)

Congratulations! Installation of your Smart Garage Control is now complete.

App Store and the Apple and App Store logos are trademarks of Apple Inc.

Google Play and the Google Play logo are trademarks of Google LLC.

Overview

Set Up Your Smart Garage Control

What you Need

Connect Your Smart Garage Control

Check Your Wi-Fi Signal

Pair the Door Sensor to the Hub

Pair a second door sensor

Mount the Door Sensor

Choose the Hub Location

Mount the Hub

How-To Video

Add myO Smart Partners and Accessories

Need Help?

Accessories and Parts

Set Up Your Smart Garage Control

Check Your Wi-Fi Signal

Make sure your device is connected to your Wi-Fi network. Hold the device where you plan to mount the hub.

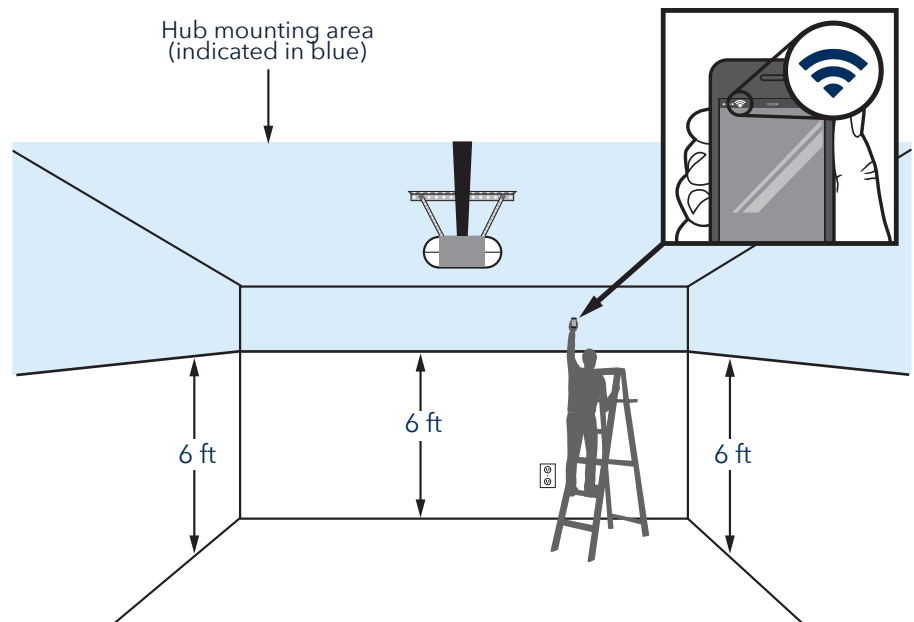

If you see:



Wi-Fi signal is strong.

You're all set! Proceed to next step.



Wi-Fi signal is weak.

The hub may not connect to your Wi-Fi network. If it doesn't connect, [see How to improve your Wi-Fi signal](#).



No Wi-Fi signal.

[See How to improve your Wi-Fi signal](#).

Overview

Set Up Your Smart Garage Control

What you Need

Connect Your Smart Garage Control

Check Your Wi-Fi Signal

Pair the Door Sensor to the Hub

Pair a second door sensor

Mount the Door Sensor

Choose the Hub Location

Mount the Hub

How-To Video

Add myQ Smart Partners and Accessories

Need Help?

Accessories and Parts

Set Up Your Smart Garage Control

Pair the Door Sensor to the Hub

The myQ app will pair the door sensor to the hub during initial set up.

Pair a second door sensor

To add a door sensor to a second garage door opener, in the myQ app tap (+) to add a door sensor. Follow the instructions in the app.

Mount the Door Sensor

Mount the door sensor (top facing up) with the included hook and loop adhesive strips or optional screws to a clean, dry area on top panel of garage door as shown. [Test the door sensor battery](#) every 6 months.

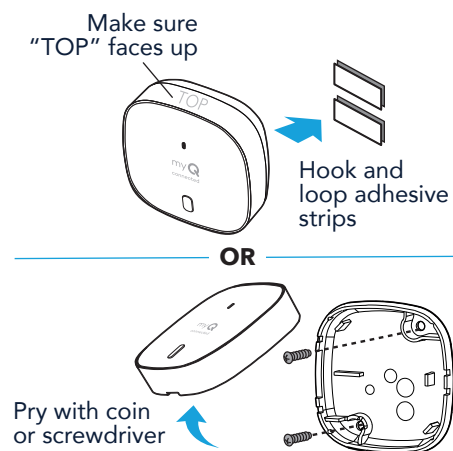
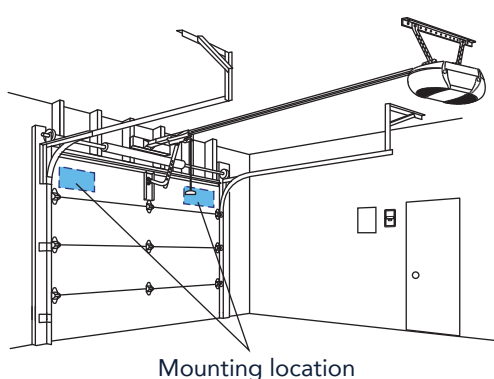

Overview

Set Up Your Smart Garage Control

What you Need

Connect Your Smart Garage Control

Check Your Wi-Fi Signal

Pair the Door Sensor to the Hub

Pair a second door sensor

Mount the Door Sensor

Choose the Hub Location

Mount the Hub

How-To Video

Add myO Smart Partners and Accessories

Need Help?

Accessories and Parts

Set Up Your Smart Garage Control

Choose the Hub Location

Find an area on the ceiling, a side wall, or opposing wall to the garage door that is:

- at least 6 feet above the ground.
- within 5 feet of an outlet.
- where the hub and light is visible at all times from within the garage.
- 4 feet away from any metal objects.

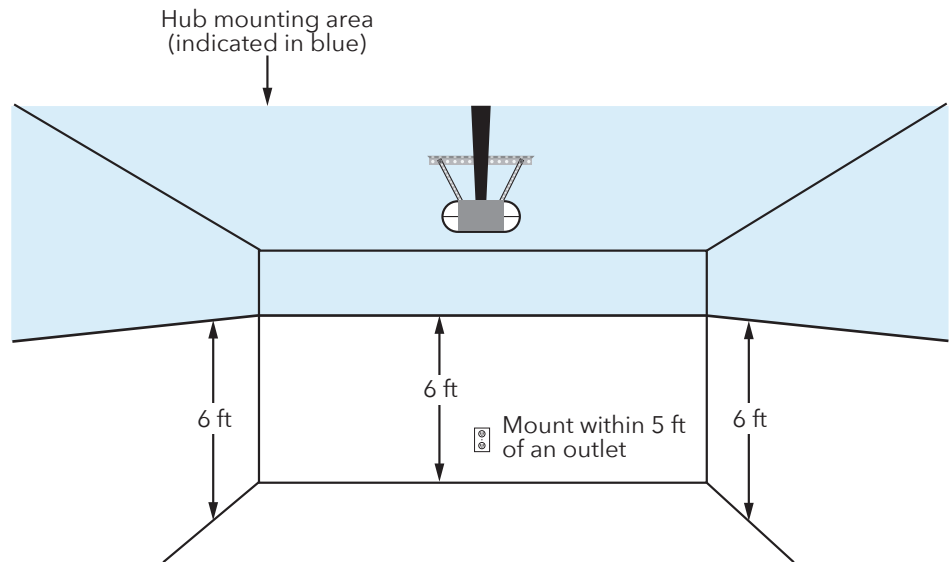

Overview

Set Up Your Smart Garage Control

What you Need

Connect Your Smart Garage Control

Check Your Wi-Fi Signal

Pair the Door Sensor to the Hub

Pair a second door sensor

Mount the Door Sensor

Choose the Hub Location

Mount the Hub

How-To Video

Add myQ Smart Partners and Accessories

Need Help?

Accessories and Parts

Set Up Your Smart Garage Control

Mount the Hub

1. With the arrow facing up, use the mounting plate to mark the drill holes.

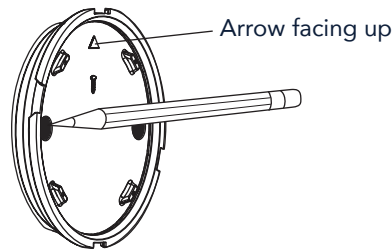

2. Drill holes using a 5/32" bit.

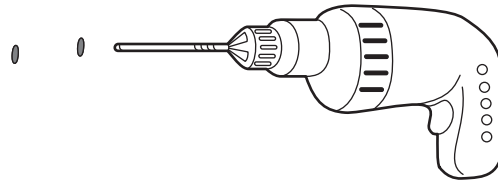

3. Insert drywall anchors until they are flush with the surface.

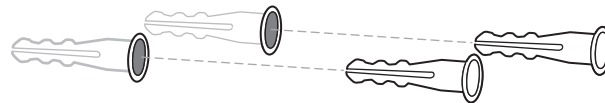

4. Attach the mounting plate with screws.

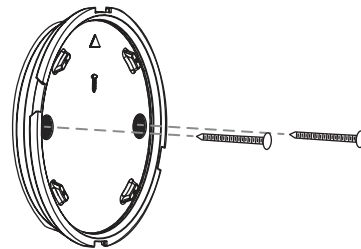

Continue



Overview

Set Up Your Smart Garage Control

What you Need

Connect Your Smart Garage Control

Check Your Wi-Fi Signal

Pair the Door Sensor to the Hub

Pair a second door sensor

Mount the Door Sensor

Choose the Hub Location

Mount the Hub

How-To Video

Add myQ Smart Partners and Accessories

Need Help?

Accessories and Parts

Set Up Your Smart Garage Control

Mount the Hub

5. Place the hub on the mounting plate at an angle and rotate until secure.

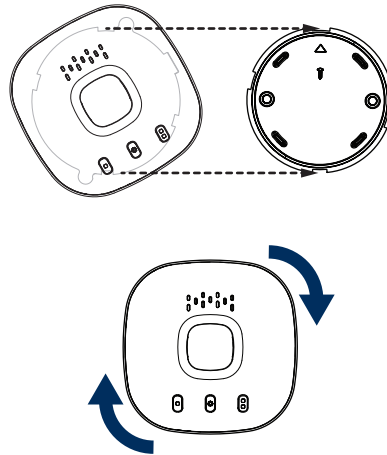

NOTE: Wrap excess power cable around the hub and mounting bracket.

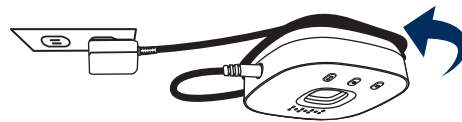

6. Attach the warning placard on the wall next to the door control.

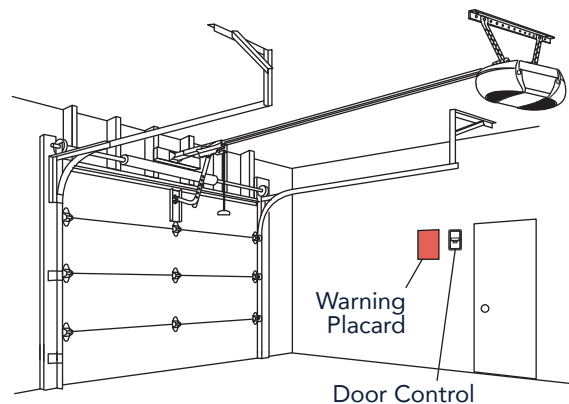

Overview

Set Up Your Smart Garage Control

What you Need

Connect Your Smart Garage Control

Check Your Wi-Fi Signal

Pair the Door Sensor to the Hub

Pair a second door sensor

Mount the Door Sensor

Choose the Hub Location

Mount the Hub

How-To Video

Add myQ Smart Partners and Accessories

Need Help?

Accessories and Parts

Set Up Your Smart Garage Control

How-To Video



[How to Install and Set Up the Chamberlain® Smart Garage™ Control Using the myQ App](#)

Overview

Set Up Your Smart Garage Control

What you Need

Connect Your Smart Garage Control

Check Your Wi-Fi Signal

Pair the Door Sensor to the Hub

Pair a second door sensor

Mount the Door Sensor

Choose the Hub Location

Mount the Hub

How-To Video

Add myQ Smart Partners and Accessories

Need Help?

Accessories and Parts

Set Up Your Smart Garage Control

Add myQ Smart Partners and Accessories

Your Smart Garage Control is compatible with a wide variety of interactive service providers and accessories.

[See myQ smart partners](#) or select **Works with myQ** in the app.

See [Accessories and Parts](#).



Overview

Set Up Your Smart Garage Control

Need Help?

Troubleshooting videos

Garage door opener compatibility

Router compatibility and settings

How to improve your Wi-Fi signal

Test the door sensor battery

Change the door sensor battery

Pair a replacement door sensor

You have reached the maximum number of doors

How to manually add a door sensor

Erase Wi-Fi settings from the hub

Reset the hub to factory default

Update my network settings in the myQ app

LED indicators

The app says Monitor Mode

App error messages

Locate a garage door opener program or learn button

Accessories and Parts

Need Help?

Troubleshooting videos



[Main Smart Garage Control connection troubleshooting guide](#)

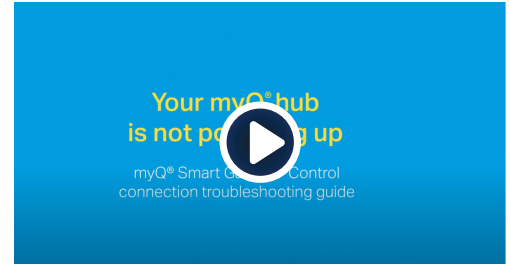

[Your Smart Garage Control hub is not powering up](#)

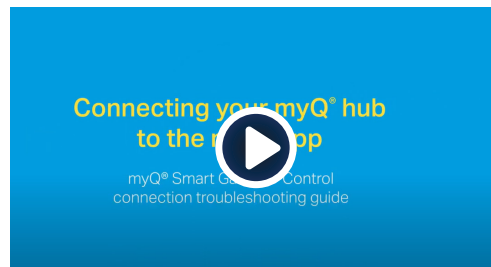

[Connecting your Smart Garage Control to the myQ app](#)



[Connecting your Smart Garage Control to the Internet](#)



[Connecting your Smart Garage Control to the garage door opener](#)

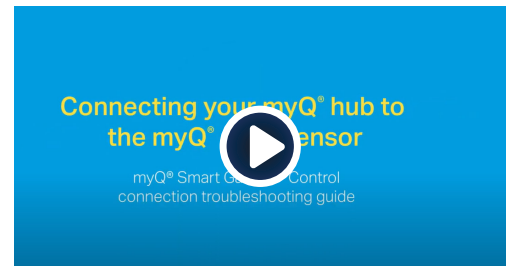

[Connecting your Smart Garage Control to the door sensor](#)

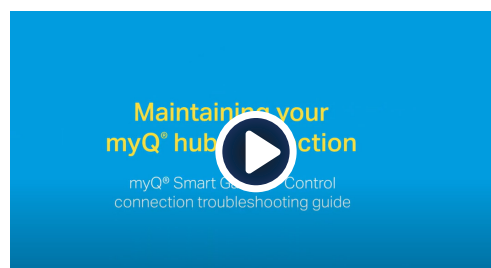

[Maintaining your Smart Garage Control's connection](#)

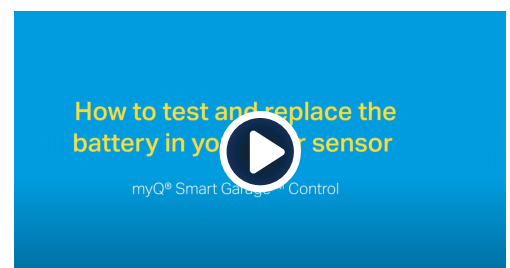

[How to test and replace the battery in your Smart Garage Control door sensor](#)

Overview

Set Up Your Smart Garage Control

Need Help?

Troubleshooting videos

Garage door opener compatibility

Router compatibility and settings

How to improve your Wi-Fi signal

Test the door sensor battery

Change the door sensor battery

Pair a replacement door sensor

You have reached the maximum number of doors

How to manually add a door sensor

Erase Wi-Fi settings from the hub

Reset the hub to factory default

Update my network settings in the myQ app

LED indicators

The app says Monitor Mode

App error messages

Locate a garage door opener program or learn button

Accessories and Parts

Need Help?

Garage door opener compatibility

The Smart Garage Control is compatible with most brands of garage door openers manufactured after 1993 that use photoelectric sensors that do not shut off. It is not intended for use with openers in which the photoelectric sensors located near the bottom of the garage door change power mode (e.g., lights on the sensors turn off after the door is closed), or any Chamberlain Group opener with a yellow learn button manufactured between 2010 and 2021, or any Linear opener. [Check opener compatibility by manufacturer.](#)

Router compatibility and settings

Make sure the router has the following settings:

- 2.4 GHz is enabled, 5 GHz is NOT compatible
- 802.11g or 802.11n (802.11 b/g/n) is enabled
- DHCP is enabled.
- Security is set to WPA2, WPA3 or WPA2/WPA3.
- Inbound and outbound /TCP port 8883 is open

[See more information about router settings and compatibility here.](#)

How to improve your Wi-Fi signal

The Wi-Fi signal in a garage can be diminished because of the structure in the walls. If you have a weak signal in your garage, try the following:

- Make sure the router is within 50 ft. of the hub.
- Move the router closer to your garage to minimize interference from walls and other objects.
- Be sure the Smart Garage Control hub is mounted in a recommended location. [Choose the Hub Location.](#)
- Use a Wi-Fi extender.

Overview

Set Up Your Smart Garage Control

Need Help?

Troubleshooting videos

Garage door opener compatibility

Router compatibility and settings

How to improve your Wi-Fi signal

Test the door sensor battery

Change the door sensor battery

Pair a replacement door sensor

You have reached the maximum number of doors

How to manually add a door sensor

Erase Wi-Fi settings from the hub

Reset the hub to factory default

Update my network settings in the myQ app

LED indicators

The app says Monitor Mode

App error messages

Locate a garage door opener program or learn button

Accessories and Parts

Need Help?

Test the door sensor battery

[Test the door sensor battery](#) every 6 months or if the Smart Garage Control is not working as expected.

1. Press and release the test button on the door sensor. The red LED on the door sensor should blink and the hub should beep.
2. Wait 5 seconds, then repeat this test 5 more times (wait 5 seconds between each test).
3. If the LED doesn't blink or the hub doesn't beep with each press, try the following:
 - Make sure you remove the pull tab from the door sensor.
 - Debris may be present on the battery. Remove the sensor cover and slide the battery out to check.
 - Replace the battery, see [Replacement Parts](#).

Change the door sensor battery

1. Pry the latch panel on the bottom of the door sensor with a coin or screwdriver and lift the top to remove it.
2. Using a soft non-conductive tool (such as a cotton swab), gently push the coin battery out of the clip.
3. Gently but firmly insert the new battery into the clip and replace the cover.

Dispose of batteries properly. Replace ONLY with 3V CR2450 coin batteries, see [Replacement Parts](#).

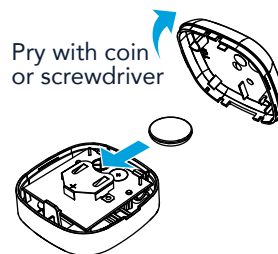

Overview

Set Up Your Smart Garage Control

Need Help?

Troubleshooting videos

Garage door opener compatibility

Router compatibility and settings

How to improve your Wi-Fi signal

Test the door sensor battery

Change the door sensor battery

Pair a replacement door sensor

You have reached the maximum number of doors

How to manually add a door sensor

Erase Wi-Fi settings from the hub

Reset the hub to factory default

Update my network settings in the myQ app

LED indicators

The app says Monitor Mode

App error messages

Locate a garage door opener program or learn button

Accessories and Parts

Need Help?

Pair a replacement door sensor

To replace an existing door sensor follow the steps below:

1. If the current door sensor is still operating and connected to a garage door opener, press the test button on the existing door sensor. The hub beeps one time if the current door sensor is door 1 or beeps twice if door 2.
2. If the current door sensor does not work and you have two door sensors connected to the hub, press the test button on the other door sensor. The hub will beep once if the other door sensor is door 1 or beep twice if door 2. You will need to select the other button on the hub for your new door sensor.
3. Remove the pull tab from the new door sensor to activate the battery.
4. On the hub, press the button for door 1 or 2, depending on the information from steps 1 and 2 above. A solid amber LED light will appear.
5. Press and release the test button on the new door sensor. The hub will flash and beep indicating successful programming.
6. [Mount the door sensor.](#)
7. In the myQ app, check that you can open and close your garage door to confirm successful programming.

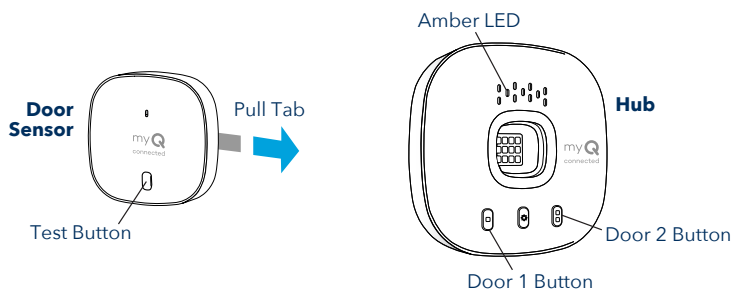

You have reached the maximum number of doors

The Smart Garage Control hub has the ability to pair two (2) door sensors and two (2) garage door openers at a time. If you try to add more than two sensors and/or garage door openers, you will receive the following error message, "Two Sensor Limit. You already have two sensors paired to this hub."

If you receive this message and do not have more than two door sensors or two garage door openers paired when trying to add a door sensor through the app, manually add the door sensor using the steps below.

Overview

Set Up Your Smart Garage Control

Need Help?

Troubleshooting videos

Garage door opener compatibility

Router compatibility and settings

How to improve your Wi-Fi signal

Test the door sensor battery

Change the door sensor battery

Pair a replacement door sensor

You have reached the maximum number of doors

How to manually add a door sensor

Erase Wi-Fi settings from the hub

Reset the hub to factory default

Update my network settings in the myQ app

LED indicators

The app says Monitor Mode

App error messages

Locate a garage door opener program or learn button

Accessories and Parts

Need Help?

How to manually add a door sensor

1. Clear the channels on the hub.
 - Press and hold button 1 on the hub until the amber LED turns off.
 - Press and hold button 2 on the hub until the amber LED turns off.
2. Press and release button 1 on the hub.
3. Press and release the test button on the door sensor.
 - The hub will beep and flash indicating successful door sensor programming.
4. Log into the myQ app.
5. A picture of the garage door will show the Monitor Door Only displayed within a blue bar.
6. Tap on the blue bar and proceed with pairing the garage door opener.

Erase Wi-Fi settings from the hub



Erasing the Wi-Fi settings allows you to reset the Wi-Fi settings on the hub.

1. The green LED MUST be on or blinking to erase Wi-Fi settings.
2. Press and hold the  button on the hub until the blue LED blinks.



Reset the hub to factory default

Resetting the hub to factory default will erase the Wi-Fi settings, and removes the device from the myQ account.

1. Press and hold the  button on the Wi-Fi hub until the blue LED starts blinking then release.
2. While the blue LED is blinking, press and hold the  button again until the blue LED pauses then blinks or beeps. The Wi-Fi hub is set to factory default..

To install and connect the hub, see [Connect Your Smart Garage Control](#).

Update my network settings in the myQ app

When you replace your router or update any of your home network settings or password, you need to update the Wi-Fi settings in the myQ app and reconnect your Smart Garage Control.

Overview

Set Up Your Smart Garage Control

Need Help?

Troubleshooting videos

Garage door opener compatibility

Router compatibility and settings

How to improve your Wi-Fi signal

Test the door sensor battery

Change the door sensor battery

Pair a replacement door sensor

You have reached the maximum number of doors

How to manually add a door sensor

Erase Wi-Fi settings from the hub

Reset the hub to factory default

Update my network settings in the myQ app

LED indicators

The app says Monitor Mode

App error messages









Locate a garage door opener program or learn button

Accessories and Parts

Need Help?

LED indicators

The LEDs indicate the status of the Smart Garage Control.

	Blinking blue and green	The hub was unable to connect to your home's Wi-Fi router.	If unable to connect: <ul style="list-style-type: none">Try moving the hub to a location in the garage closer to your home's Wi-Fi router.Unplug the power cord for your router and plug it back in. Note: this will disconnect all your devices.Be sure the hub is not blocked by any additional network security (Firewall, MAC filtering).Update the Wi-Fi settings on your hub by going to device management in the myQ app.
	Blinking blue	The hub is attempting to connect to your mobile device.	If unable to connect: <ul style="list-style-type: none">Check that Bluetooth is enabled to setup your myQ device.Check that you are entering the correct network password.
	Solid blue	The hub was unable to connect to your home Wi-Fi network.	<ul style="list-style-type: none">Unplug power to your hub and plug it back in. If it's not blinking blue, press and hold the  button until the LED goes to a blinking blue.Disable and re-enable Bluetooth on your mobile device.
	Blinking green	The hub was unable to connect to the internet or myQ server.	If unable to connect: <ul style="list-style-type: none">Unplug power to the router and plug it back in.Be sure the hub is not blocked by any additional network security (Firewall, MAC filtering)Make sure router TCP/UDP port 8883 is open, see Router compatibility and settings.
	Solid green	The hub has successfully connected to the myQ server.	
	Solid amber	Door button 1 or 2 has been pressed	Press the test button on the door sensor to pair the sensor with the hub.
	Blinking amber	Door sensor is pairing to the hub.	

Overview

Set Up Your Smart Garage Control

Need Help?

Troubleshooting videos

Garage door opener compatibility

Router compatibility and settings

How to improve your Wi-Fi signal

Test the door sensor battery

Change the door sensor battery

Pair a replacement door sensor

You have reached the maximum number of doors

How to manually add a door sensor

Erase Wi-Fi settings from the hub

Reset the hub to factory default

Update my network settings in the myQ app

LED indicators

The app says Monitor Mode

App error messages

Locate a garage door opener program or learn button

Accessories and Parts

Need Help?

LED indicators

The LEDs indicate the status of the Smart Garage Control.

	No LED	The hub is idle or there is no power to the hub.	<ul style="list-style-type: none">• Unplug power cord to the hub and plug back in. The hub should show a blinking blue LED.• If there is no blinking blue LED, plug a working lamp into the same power outlet to check the outlet is providing power. If the lamp does not turn on, check the circuit breaker.• If the lamp does turn on, try plugging the hub into another outlet in the home that is providing power. If there is no blinking blue LED on the hub, replace the hub.
--	--------	--	---

Overview

Set Up Your Smart Garage Control

Need Help?

Troubleshooting videos

Garage door opener compatibility

Router compatibility and settings

How to improve your Wi-Fi signal

Test the door sensor battery

Change the door sensor battery

Pair a replacement door sensor

You have reached the maximum number of doors

How to manually add a door sensor

Erase Wi-Fi settings from the hub

Reset the hub to factory default

Update my network settings in the myQ app

LED indicators

The app says Monitor Mode

App error messages

Locate a garage door opener program or learn button

Accessories and Parts

Need Help?

The app says *Monitor Mode*

The door sensor is paired to the hub, but the garage door opener is not.

- In the myQ app tap *Monitor Mode*, this will attempt to pair the garage door opener to the hub. Try to open and close the garage door in the app.
- If the hub is mounted on the ceiling move it to a location 6 feet off the ground, and 4 feet from any large metal objects. From the wall mounted door control, open and close the garage door twice.

App error messages

Close error

A close error occurs when the door is commanded to close from the app and is unable to close twice consecutively.

- Use your remote or the wall-mounted door panel button to close the garage door.
- If the garage door is not closing, check for an obstruction, check for an obstruction in the safety sensor beam. Remove any obstructions and confirm the door opens and closes from the wall mounted door control or a remote.
- If the hub is mounted on the ceiling move it to a location 6 feet off the ground, and 4 feet from any large metal objects. From the wall mounted door control, open and close the garage door twice.
- Replace the battery in the door sensor. See [Test the door sensor battery](#).

Off line error

Your Smart Garage Control has lost connection to the router and cannot be controlled by the myQ app.

- Check that the hub is plugged in and has power.
- The router may have lost connection to the Internet. Check the router and follow the instructions that came with it to reconnect to the Internet.
- Tap the error message in the app and follow the instructions.

Overview

Set Up Your Smart Garage Control

Need Help?

Troubleshooting videos

Garage door opener compatibility

Router compatibility and settings

How to improve your Wi-Fi signal

Test the door sensor battery

Change the door sensor battery

Pair a replacement door sensor

You have reached the maximum number of doors

How to manually add a door sensor

Erase Wi-Fi settings from the hub

Reset the hub to factory default

Update my network settings in the myQ app

LED indicators

The app says Monitor Mode

App error messages

Locate a garage door opener program or learn button

Accessories and Parts

Need Help?

Locate a garage door opener program or learn button

Chamberlain® Products

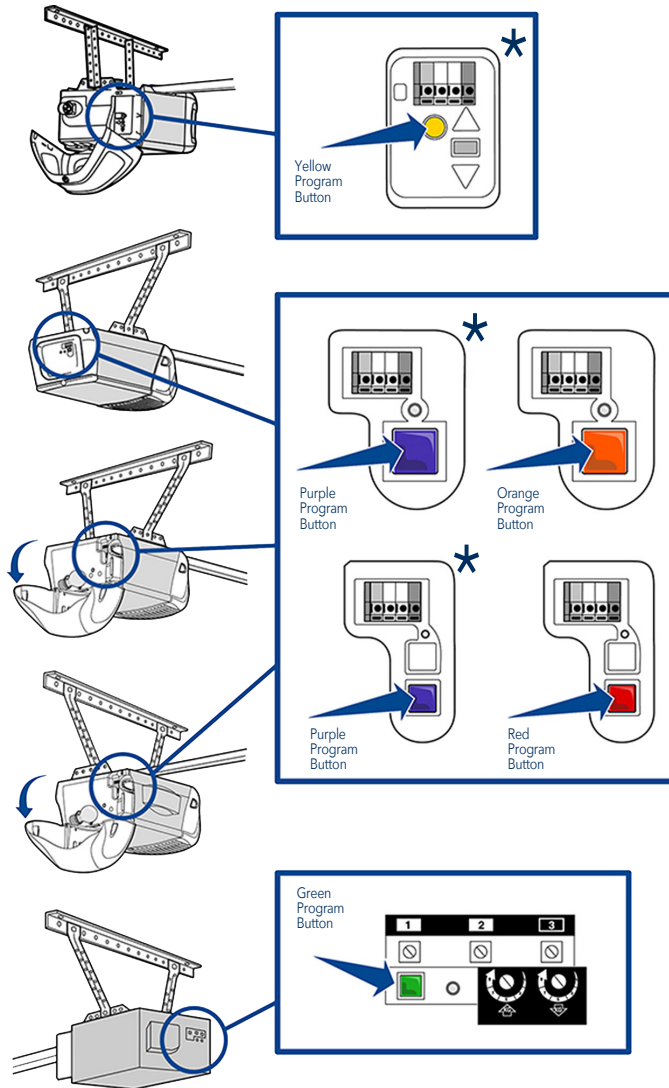

* Within the US: The Smart Garage Control is not intended for use with garage door openers in which the photoelectric sensors located near the bottom of the garage door change power mode (e.g., lights on the sensors turn off after the door is closed), or any Chamberlain Group opener with a yellow learn button manufactured between 2010 and 2021.

Overview

Set Up Your Smart Garage Control

Need Help?

Troubleshooting videos

Garage door opener compatibility

Router compatibility and settings

How to improve your Wi-Fi signal

Test the door sensor battery

Change the door sensor battery

Pair a replacement door sensor

You have reached the maximum number of doors

How to manually add a door sensor

Erase Wi-Fi settings from the hub

Reset the hub to factory default

Update my network settings in the myQ app

LED indicators

The app says Monitor Mode

App error messages

Locate a garage door opener program or learn button

Accessories and Parts

Need Help?

Locate a garage door opener program or learn button

LiftMaster® Products

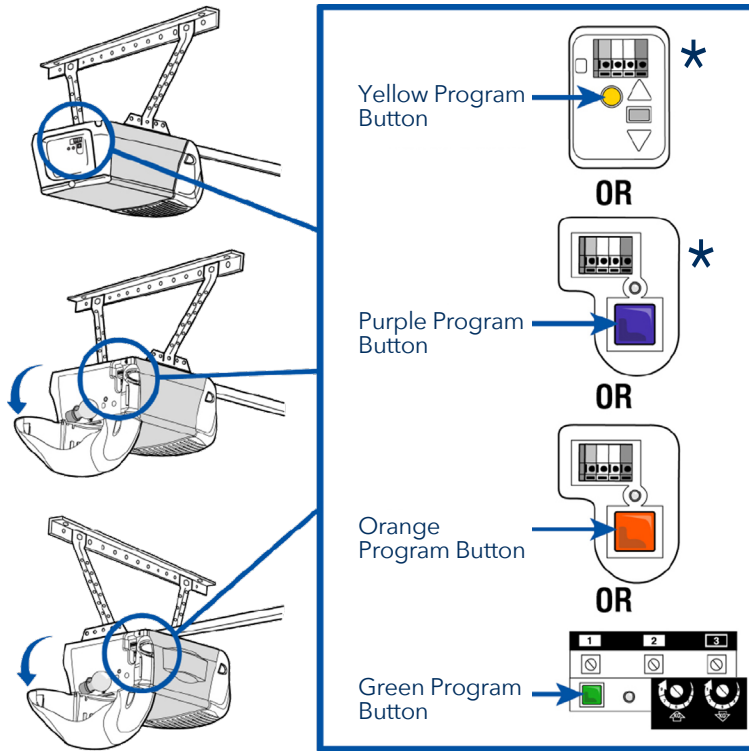

* Within the US: The Smart Garage Control is not intended for use with garage door openers in which the photoelectric sensors located near the bottom of the garage door change power mode (e.g., lights on the sensors turn off after the door is closed), or any Chamberlain Group opener with a yellow learn button manufactured between 2010 and 2021.

Overview

Set Up Your Smart Garage Control

Need Help?

- Troubleshooting videos
- Garage door opener compatibility
- Router compatibility and settings
- How to improve your Wi-Fi signal
- Test the door sensor battery
- Change the door sensor battery
- Pair a replacement door sensor
- You have reached the maximum number of doors
- How to manually add a door sensor
- Erase Wi-Fi settings from the hub
- Reset the hub to factory default
- Update my network settings in the myQ app
- LED indicators
- The app says Monitor Mode
- App error messages
- Locate a garage door opener program or learn button

Accessories and Parts

Need Help?

Locate a garage door opener program or learn button

Genie Products

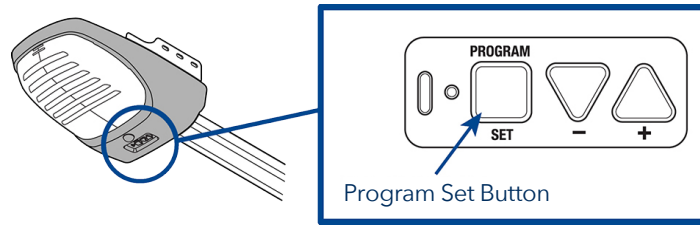
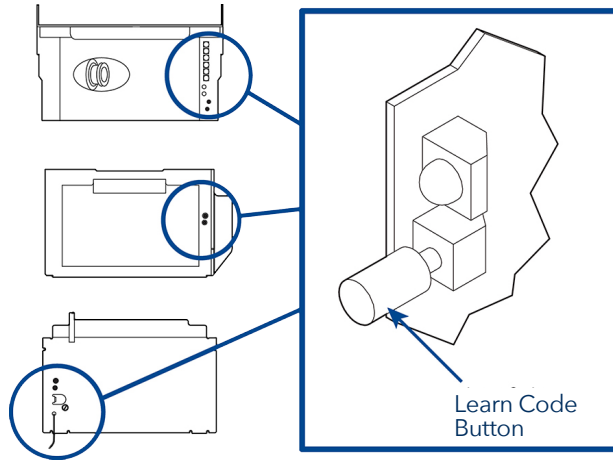

Overhead Door Products

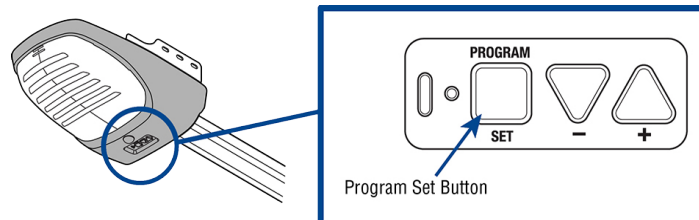
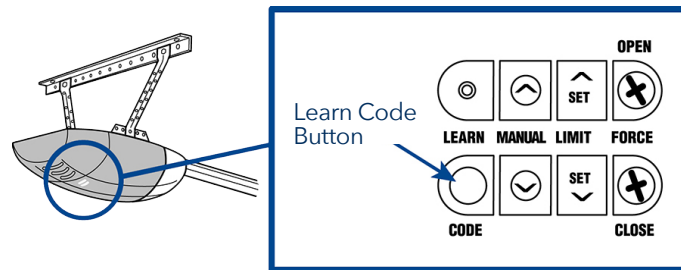

Overview

Set Up Your Smart Garage Control

Need Help?

Troubleshooting videos

Garage door opener compatibility

Router compatibility and settings

How to improve your Wi-Fi signal

Test the door sensor battery

Change the door sensor battery

Pair a replacement door sensor

You have reached the maximum number of doors

How to manually add a door sensor

Erase Wi-Fi settings from the hub

Reset the hub to factory default

Update my network settings in the myQ app

LED indicators

The app says Monitor Mode

App error messages

Locate a garage door opener program or learn button

Accessories and Parts

Need Help?

Locate a garage door opener program or learn button

Wayne Dalton Products

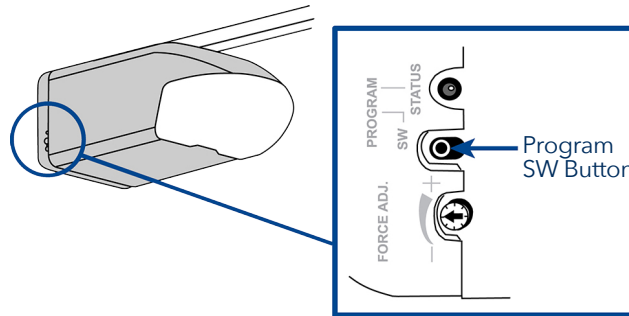

Stanley Products

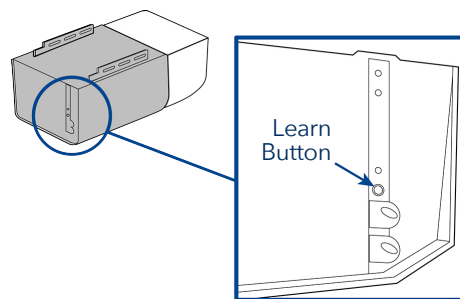

Sommer Products

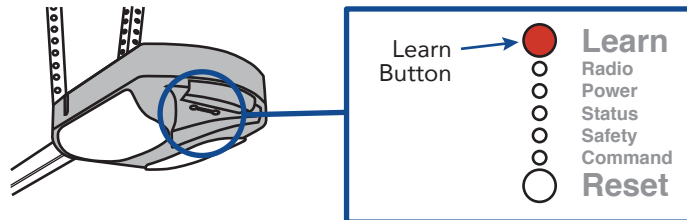

Guardian / Xtreme Garage / Performax

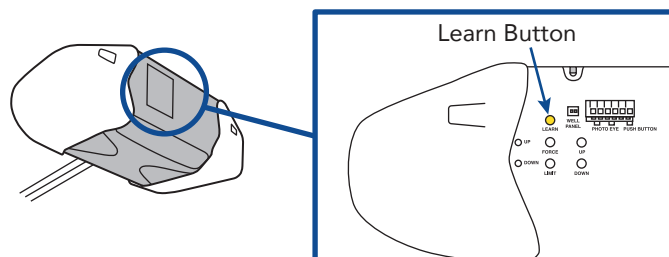
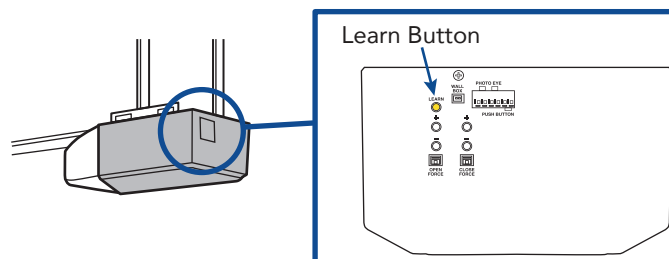

Overview

Set Up Your Smart Garage Control

Need Help?

Troubleshooting videos

Garage door opener compatibility

Router compatibility and settings

How to improve your Wi-Fi signal

Test the door sensor battery

Change the door sensor battery

Pair a replacement door sensor

You have reached the maximum number of doors

How to manually add a door sensor

Erase Wi-Fi settings from the hub

Reset the hub to factory default

Update my network settings in the myQ app

LED indicators

The app says Monitor Mode

App error messages

Locate a garage door opener program or learn button

Accessories and Parts

Accessories and Parts

Accessories



Smart Garage Control Door Sensor

Adds smart control of a second garage door opener.

MYQ-G0402



Remote Light Control

Monitor and control this plug-in lamp switch with the myQ App.

PILCEV-P1



Remote LED Light

Easily mounts in minutes to provide light to any location in the garage.

MYQLED1



Remote Light Switch

Replaces an existing wall switch to enable home lighting control with a smartphone or remote.

WSLCEV-P1

Replacement Parts



Smart Garage Control Power Supply

041-0106



Door Sensor Battery 3V CR2450

K010A0056

Overview

Set Up Your Smart Garage Control

Need Help?

Accessories and Parts

One Year Limited Warranty

The Chamberlain Group LLC warrants to the first consumer purchaser of this product that it is free from defect in materials and/or workmanship for a period of 1 year from the date of purchase.

Software Agreement

Use of this product and the software embedded within the product is subject to the copyright notices, terms, and conditions available at www.myChamberlain.com/agreement.

WARNING

To reduce the risk of SEVERE INJURY to persons:

- DO NOT enable the Chamberlain® Smart Garage™ Control if operating either one-piece or swinging doors. Enable this device with sectional doors ONLY.



If using the Smart Garage Control with residential door openers, the control must be used only with door openers manufactured after 1993 that use photoelectric sensors located near the bottom of the door track that do not change the state of those photoelectric sensors to a low power mode.



WARNING: This product can expose you to chemicals including lead, which are known to the State of California to cause cancer or birth defects or other reproductive harm. For more information go to www.P65Warnings.ca.gov.

NOTICE: This device complies with Part 15 of the FCC rules and Industry Canada's license-exempt RSSs. Operation is subject to the following two conditions: (1) this device may not cause harmful interference, and (2) this device must accept any interference received, including interference that may cause undesired operation.

Any changes or modifications not expressly approved by the party responsible for compliance could void the user's authority to operate the equipment.

This device must be installed to ensure a minimum 20 cm (8 in.) distance is maintained between users/ bystanders and device.

This device has been tested and found to comply with the limits for a Class B digital device, pursuant to part 15 of the FCC rules and Industry Canada ICES standard. These limits are designed to provide reasonable protection against harmful interference in a residential installation. This equipment generates, uses and can radiate radio frequency energy and, if not installed and used in accordance with the instructions, may cause harmful interference to radio communications. However, there is no guarantee that interference will not occur in a particular installation. If this equipment does cause harmful interference to radio or television reception, which can be determined by turning the equipment off and on, the user is encouraged to try to correct the interference by one or more of the following measures:

Reorient or relocate the receiving antenna.

Increase the separation between the equipment and receiver.

Connect the equipment into an outlet on a circuit different from that to which the receiver is connected.

Consult the dealer or an experienced radio/TV technician for help.

Chamberlain, the Chamberlain logo, LiftMaster, myQ and the myQ logo are registered trademarks of The Chamberlain Group LLC. Patented and patents pending. See ChamberlainGroup.com/patents. Wi-Fi® is a trademark of Wi-Fi Alliance®. Overhead Door and Wayne Dalton are trademarks of Overhead Door Corporation. Genie is a trademark of GMI Holdings, Inc. Stanley is a trademark of Stanley Logistics L.L.C. Sommer is a trademark of Sommer Antriebs-und Funktechnik GmbH. Guardian is a trademark of ADH Guardian USA LLC. Xtreme Garage and Performax are trademarks of Menard, Inc. All other trademarks are the property of their respective owners.

©2022 The Chamberlain Group LLC
All Rights Reserved.
114-5737-000